

REVISION RECORD	
LTR	DATE

1

2

3

4

5

6

7

8

9

10

11

12

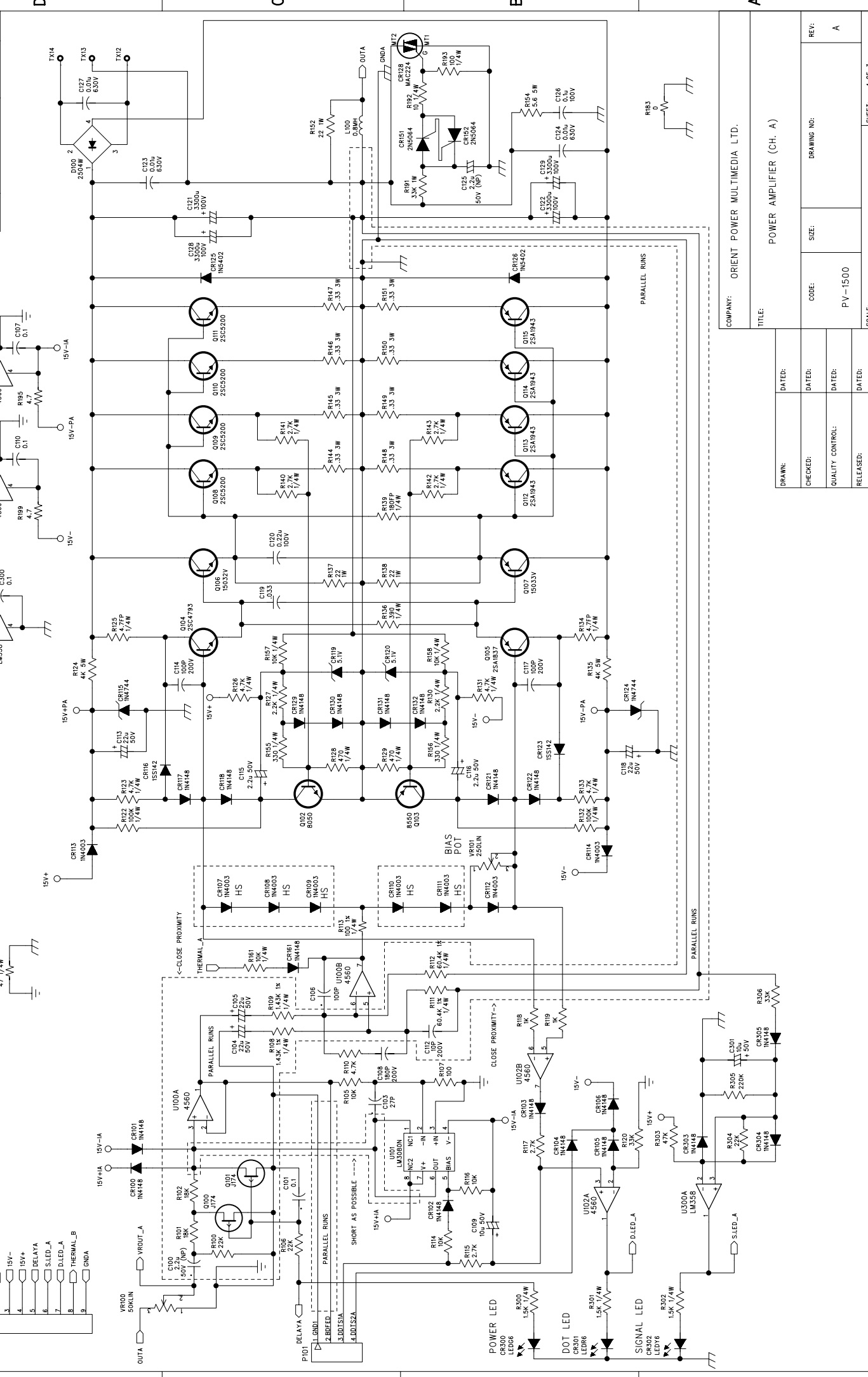

D

C

B

A

COMPANY: ORIENT POWER MULTIMEDIA LTD.	
TITLE: POWER AMPLIFIER (CH. A)	
DRAWN:	DATED:
CHECKED:	DATED:
QUALITY CONTROL:	DATED:
RELEASED:	DATED:
CODE:	SIZE:
PV-1500	
SCALE:	SHEET: 1 OF 3

REV: A

DRAWING NO:

REVISION RECORD		
LTR	ECD NO.	APPROVED:

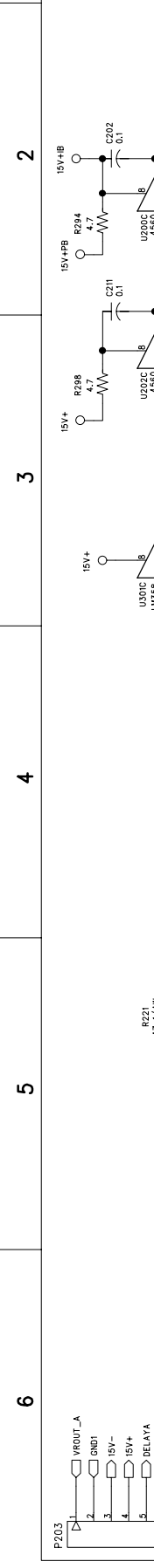

1 2 3 4 5 6

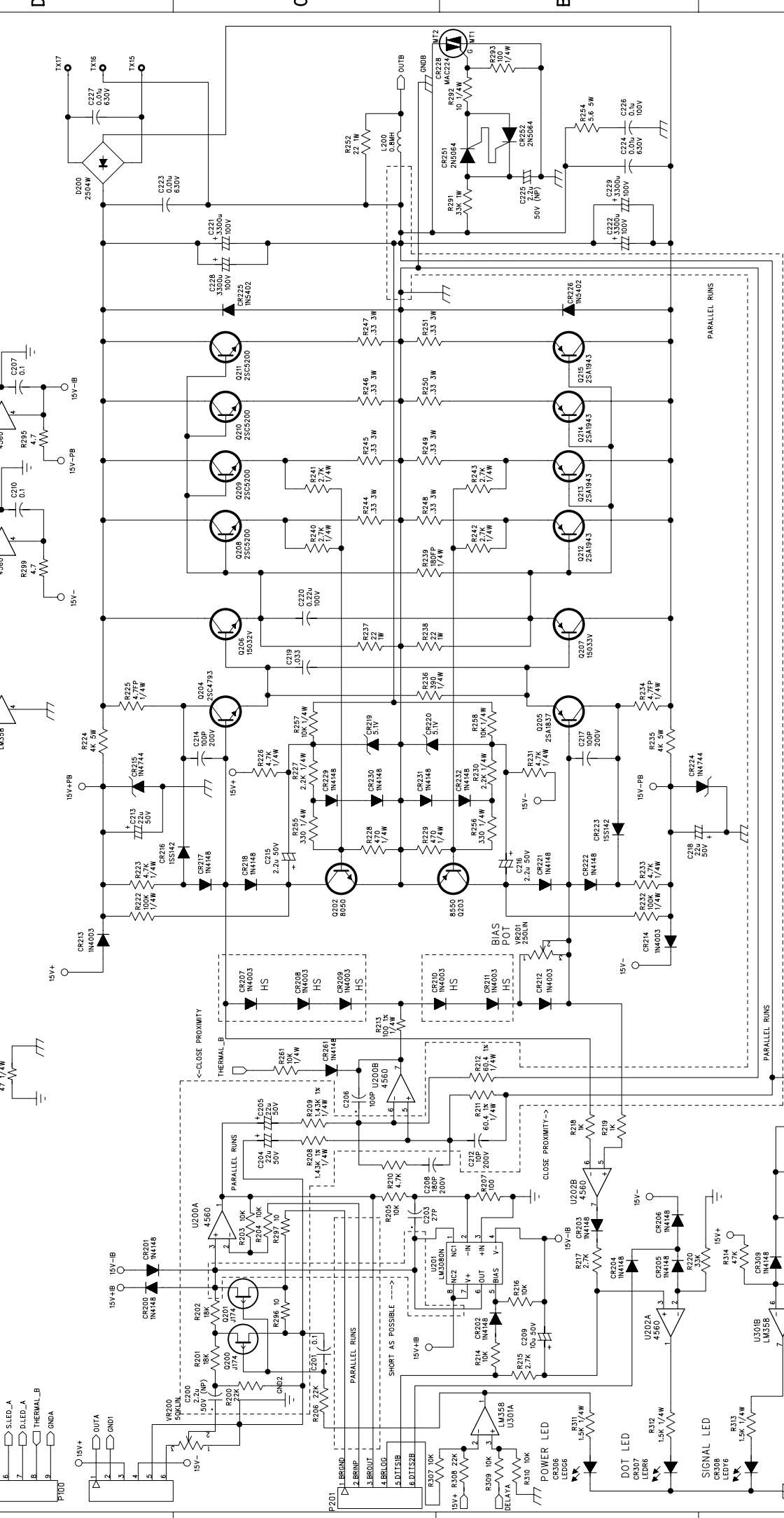

D C B A

COMPANY: ORIENT POWER MULTIMEDIA LTD.		DRAWING NO: PV-1500		SCALE: 2 OF 3	
TITLE: POWER AMPLIFIER (CH. B)		CODE: PV-1500		REV: A	
DRAWN:	CHECKED:	QUALITY CONTROL:	RELEASED:	DATED:	DATED:
DATED:	DATED:	DATED:	DATED:	SIZE:	DRAWING NO:

REVISION RECORD	
LTR	DATE:

1

2

3

4

5

6

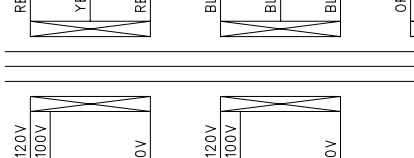
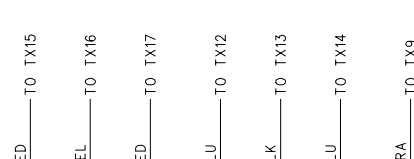
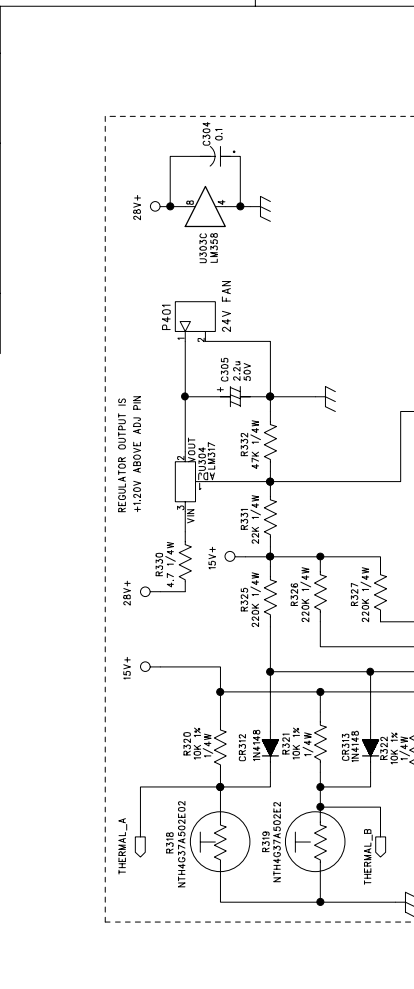

MAINS SELECT	
240V	120V 100V
PRIMARY LEADS	
GRY	RED
BRN	WHI
RED	GRY
BLK	-
BRN	-
WHI	BRN
BLK	BLK
BLU	BLU
CIRCUIT BREAKER	
7.5A	15A
250V	125V
SURGE LIMITER	
15A	30A
2 ohm	1 ohm
	1 ohm

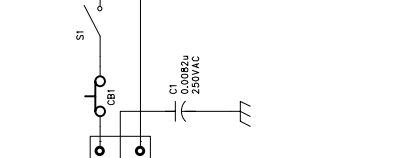
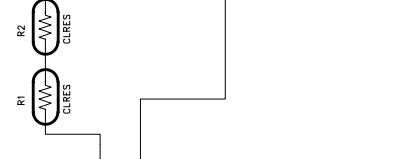
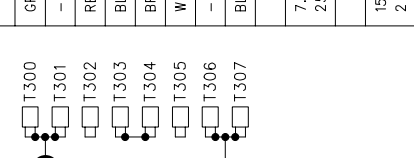

COMPANY: ORIENT POWER MULTIMEDIA LTD.

TITLE: POWER AMP (OUTPUT, POWER SUPPLY, COMMON THERMAL MANAGEMENT & TIME DELAY CIRCUITRY)

DRAWN: DATED: CHECKED: DATED: QUALITY CONTROL: DATED: RELEASED: DATED:

CODE: SIZE: DRAWING NO: REV: PV-1500 A

SCALE: SHEET: 3 OF 3

COMMON THERMAL MANAGEMENT & TIME DELAY CIRCUITRY

LOGIC LO BELOW 60C (LO FAN)
LOGIC HI ABOVE 60C (HI FAN)
DTH D-205 THERMAL DEVICE
RESISTANCE - TEMPERATURE
2000 OHMS - 50C
1800 OHMS - 60C (FAN HIGH)
1000 OHMS - 75C
500 OHMS - 100C (AMP THERM)
250 OHMS - 125C
150 OHMS - 150C
LOGIC HI BELOW 100C (AMP ON)
LOGIC LO ABOVE 100C (AMP OFF)
ADJUST R328 & R329 FOR HYSTERESIS

LOW VOLTAGE POWER SUPPLY CIRCUITRY

PART OF OUTPUT BOARD CIRCUITRY