

NOTA:
 -Resistores 5% 1/2W, quando não especificado
 -Capacitores 5%, quando não especificado
 -Sujeito a alterações sem aviso prévio



Desenhado por: **Alan**
 Revisão 1 por: **Adriano**
 Data: **25/09/2006**

Visto: _____
 Revisão 2 por: _____
 Data: _____

Seção: **Classe A**
 Equipamento: **PP-6002**

Versão: **01**
 Página: **1/1**

Observações: _____
 Recebido por: _____
 Setor: _____
 Visto: _____

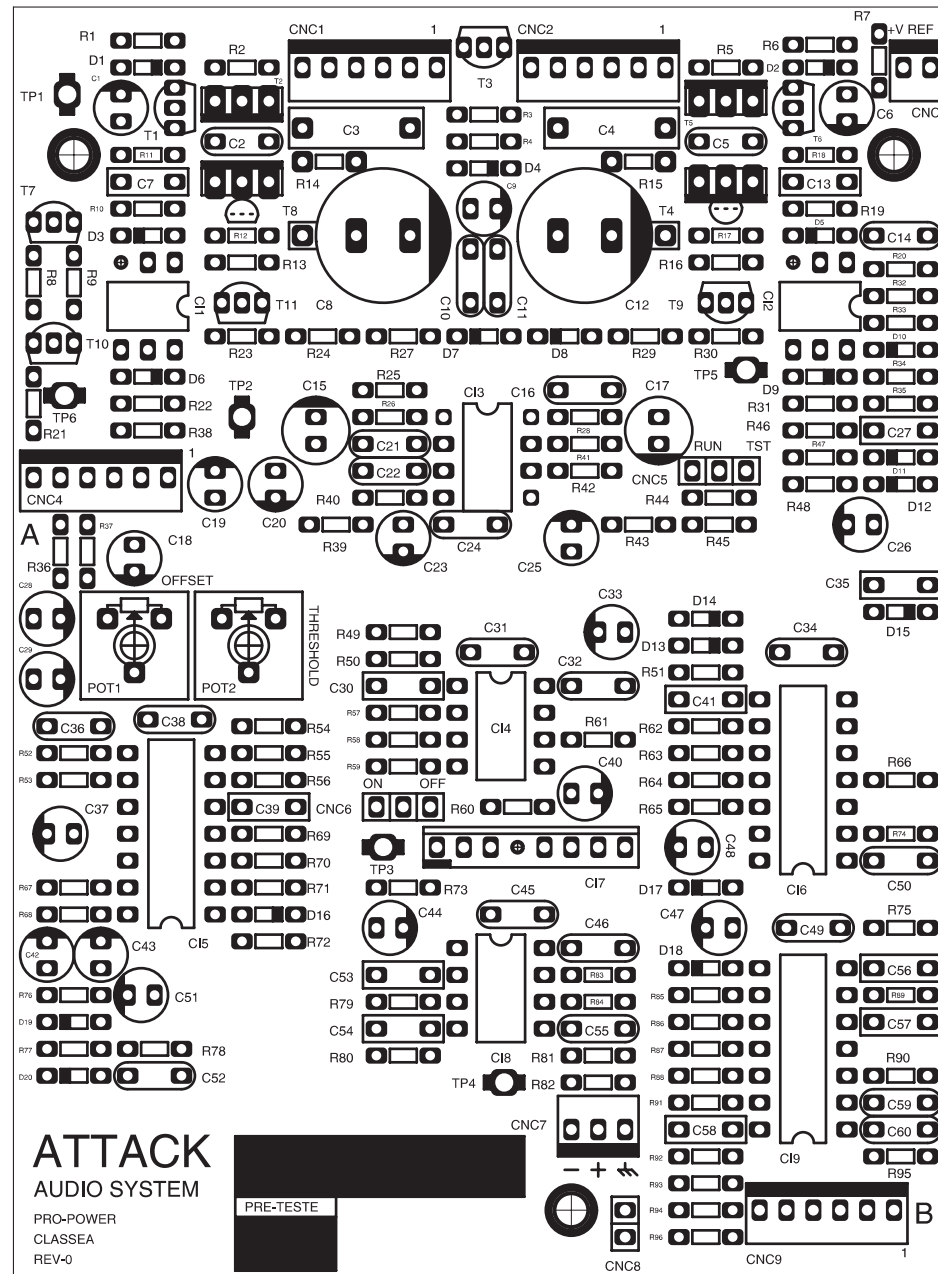

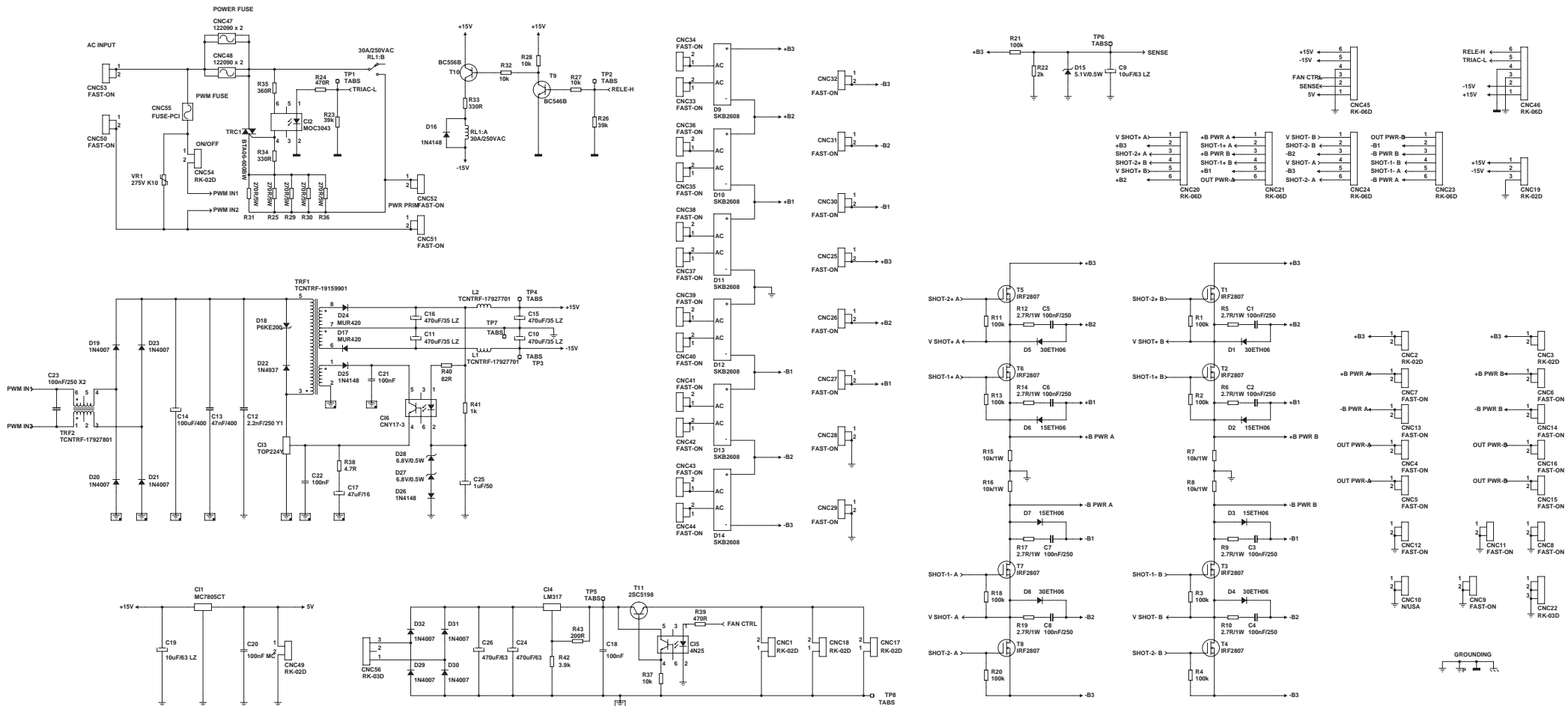

NOTA:
 -Resistores 5% 1/2W, quando não especificado
 -Capacitores 5%, quando não especificado
 -Sujeito a alterações sem aviso prévio



Desenhado por: **Alan Adriano**
 Revisão 1 por: **Adriano Adriano**
 Data: **25/09/2006** Data: **25/09/2006**

Visto: _____
 Revisão 2 por: _____
 Data: _____

Visto: _____
 Seção: **Fonte**
 Equipamento: **PP-6002**

Versão: **01**
 Página: **1/1**

Observações: _____

Recebido por: _____
 Setor: _____
 Visto: _____

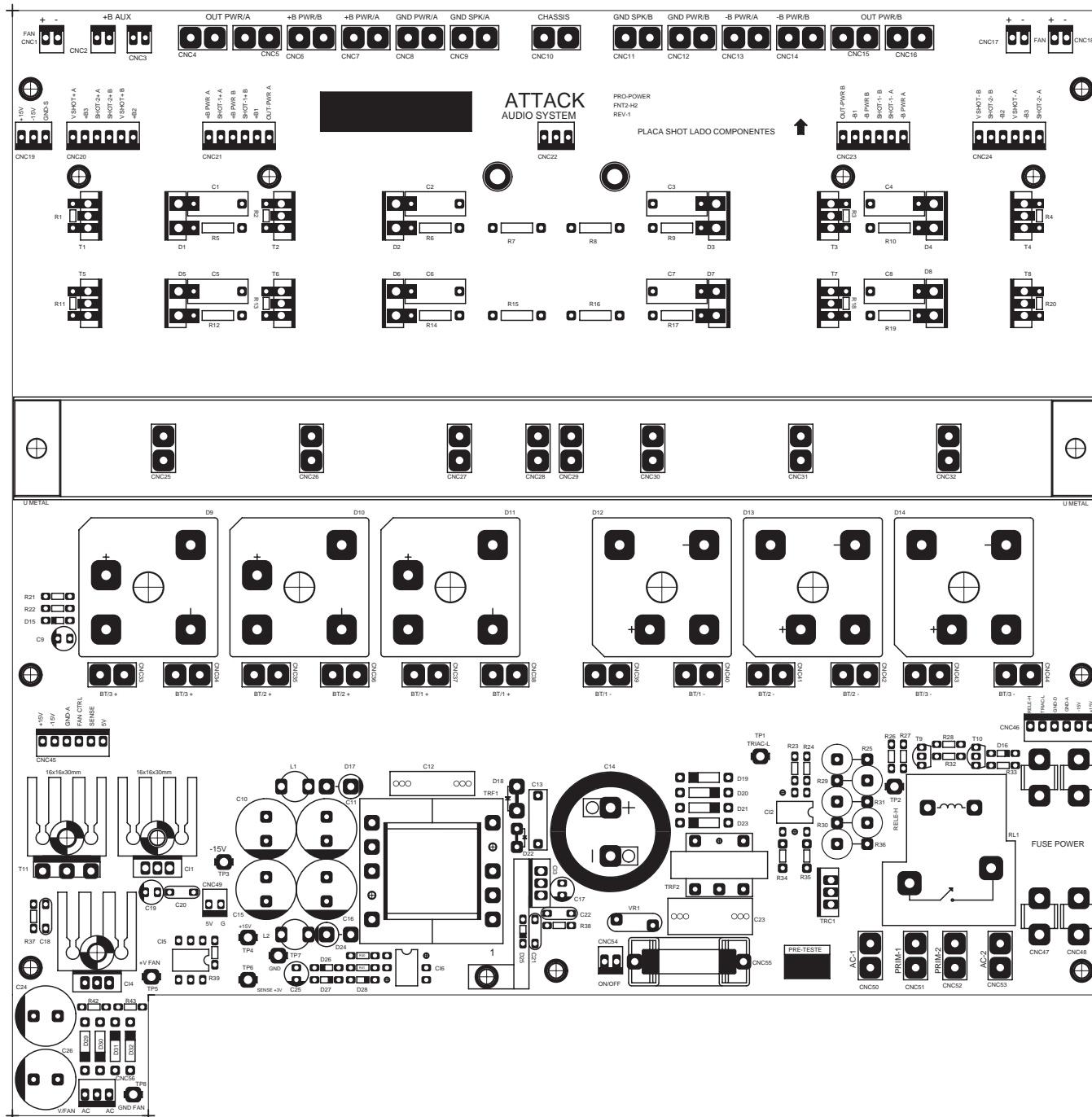

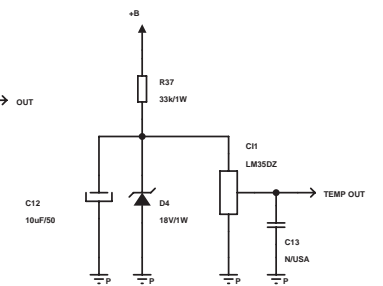
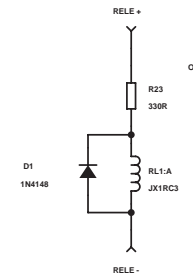
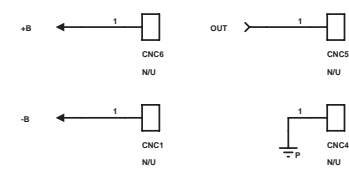
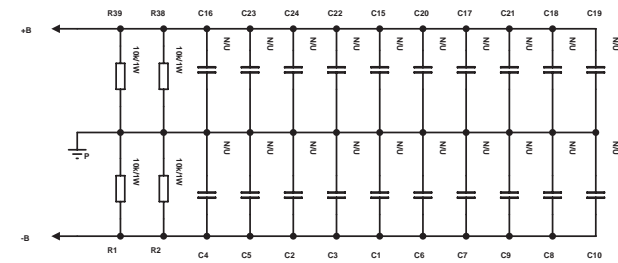
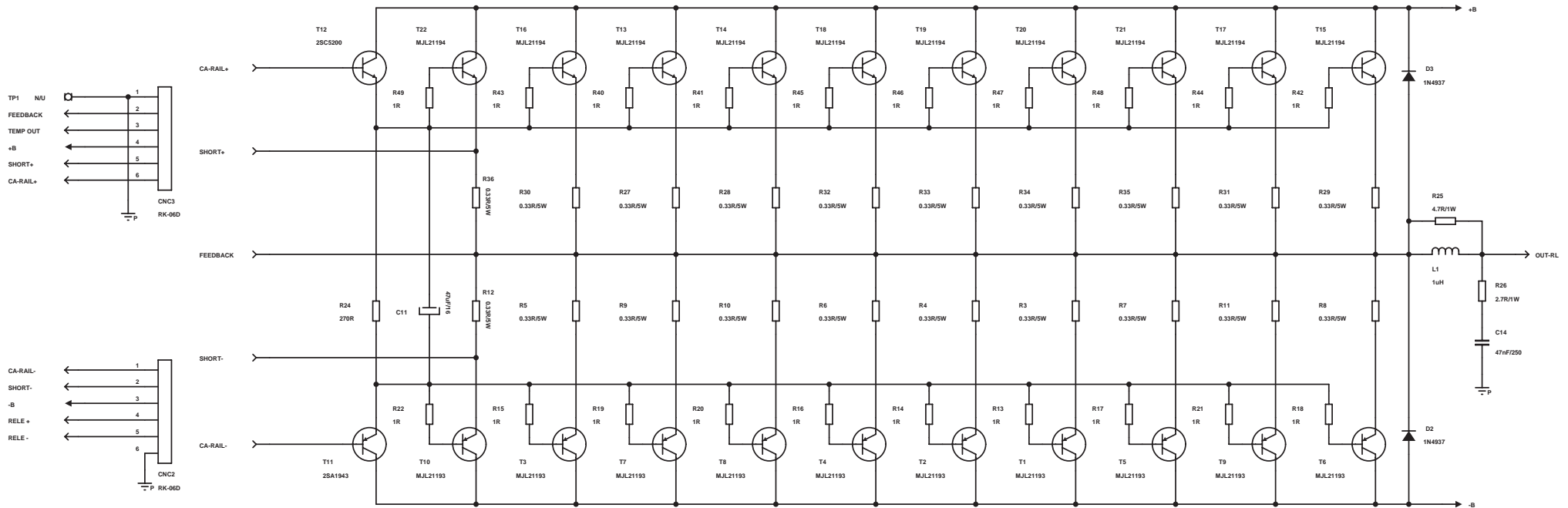

NOTA:
 -Resistores 5% 1/2W, quando não especificado
 -Capacitores 5%, quando não especificado
 -Sujeito a alterações sem aviso prévio



Desenhado por: **Alan**
 Revisão 1 por: **Adriano**
 Data: **25/09/2006**

Visto: _____
 Revisão 2 por: _____
 Data: _____

Visto: _____
 Seção: **OUT**
 Equipamento: **PP-6002**

Versão: **01**
 Página: **1/1**

Observações: _____

Recebido por: _____
 Setor: _____
 Visto: _____

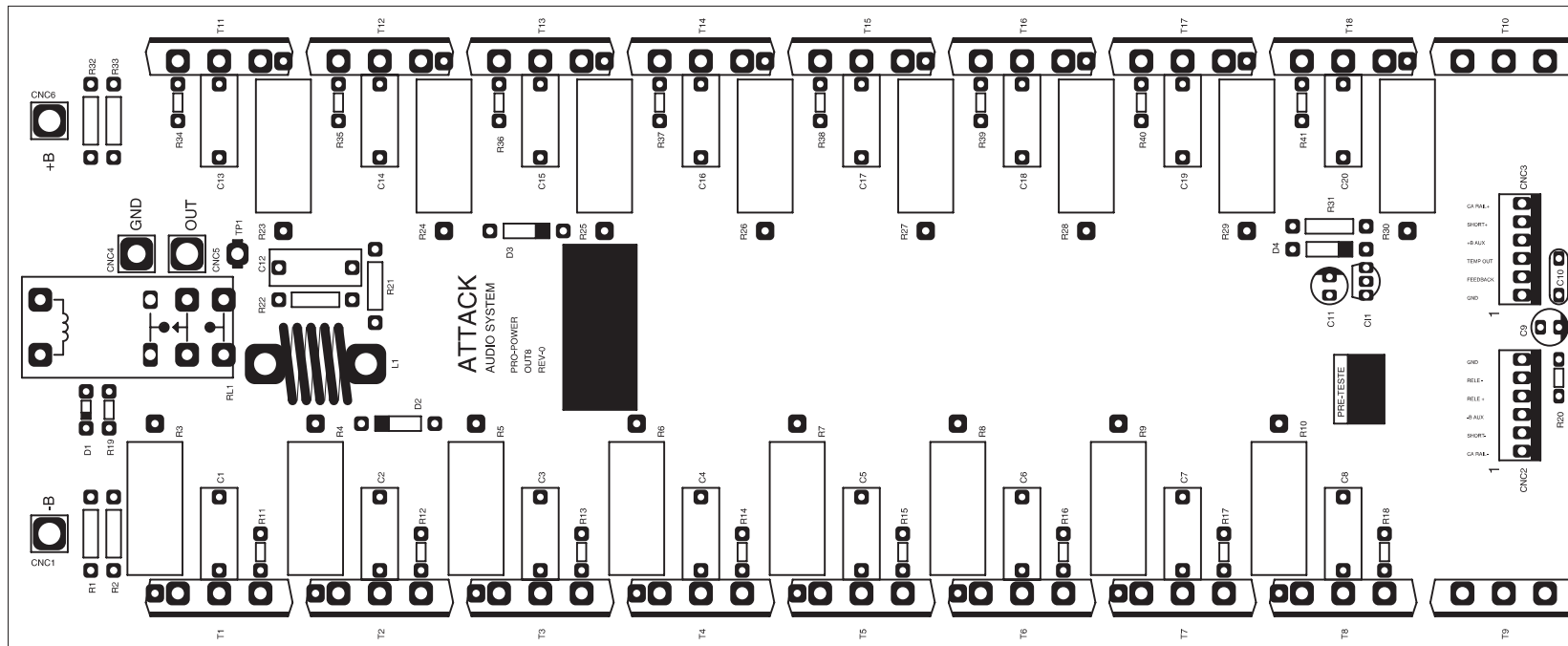

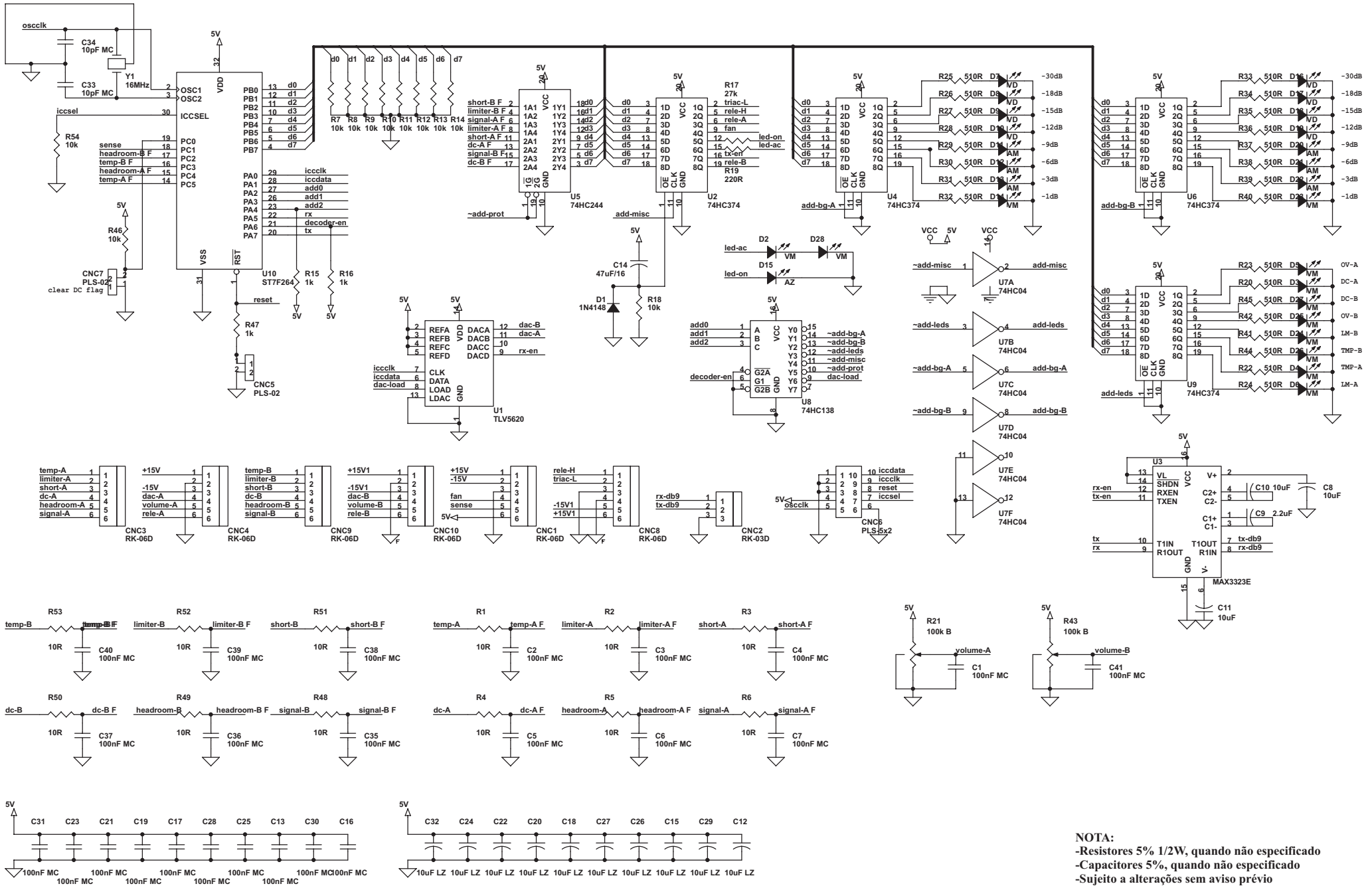

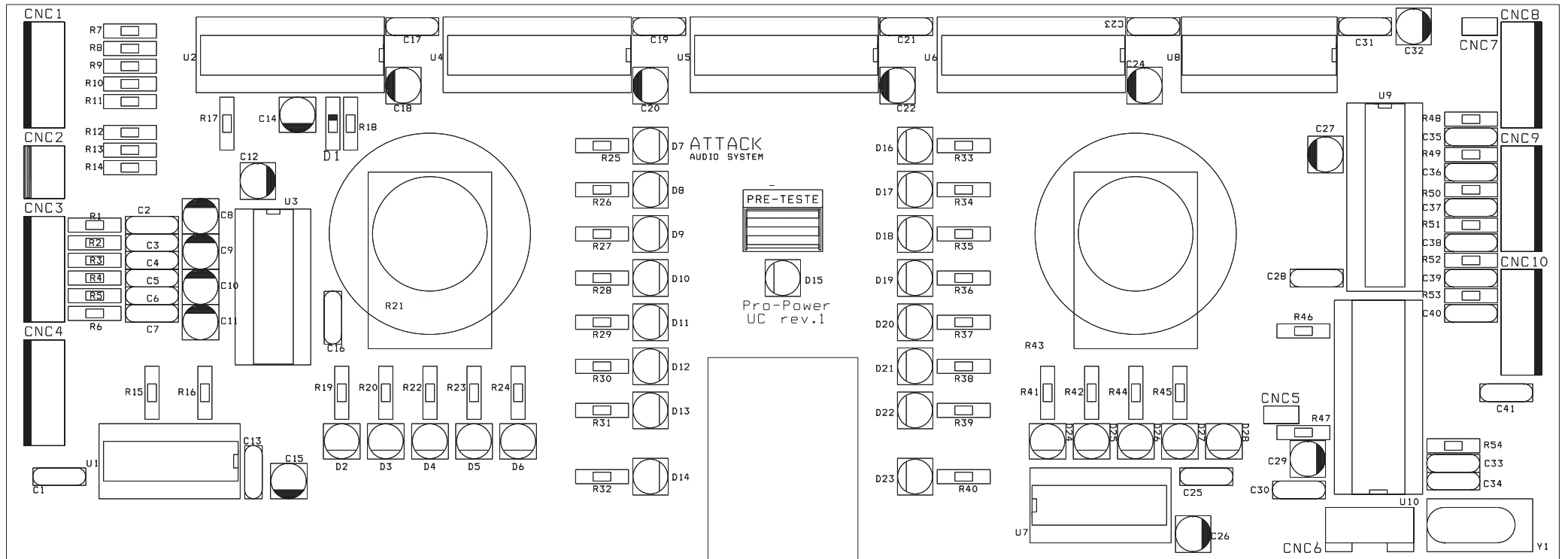

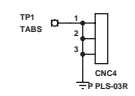
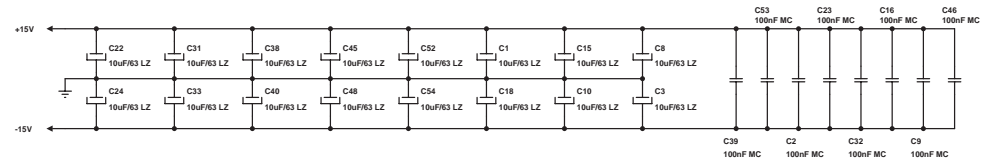
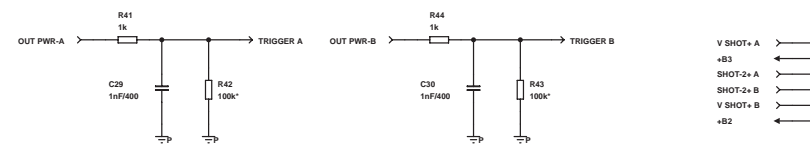
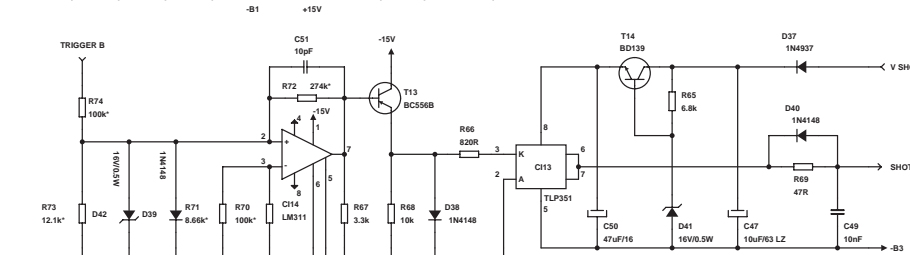
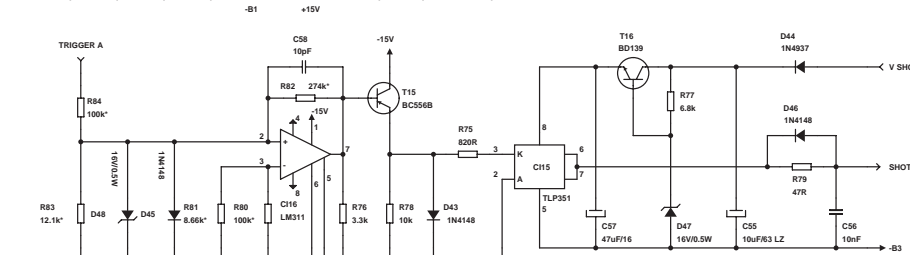
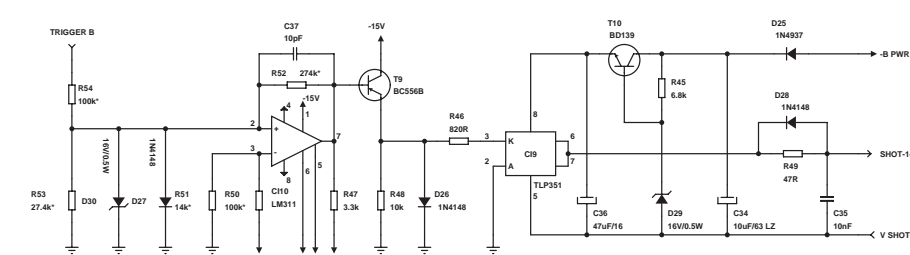
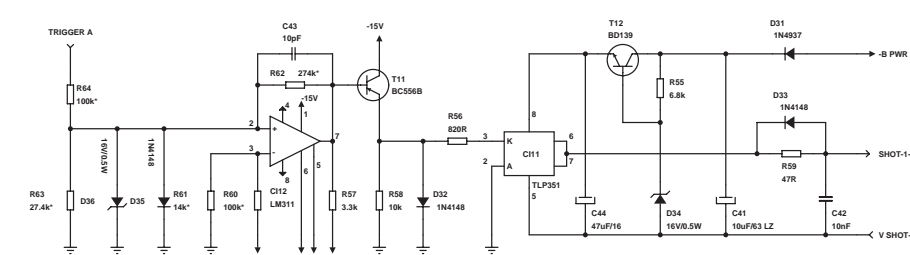
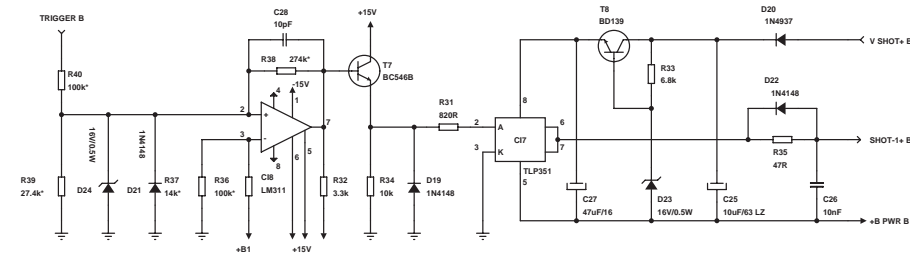
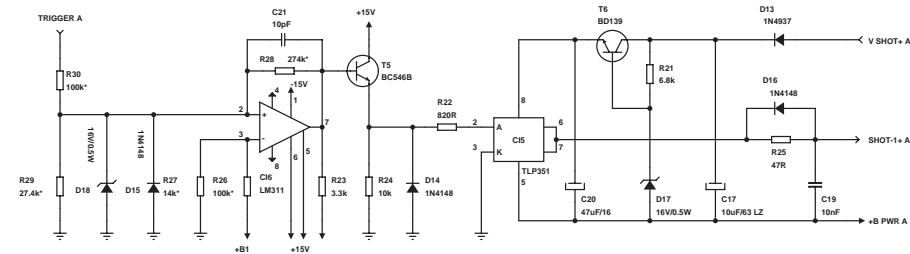
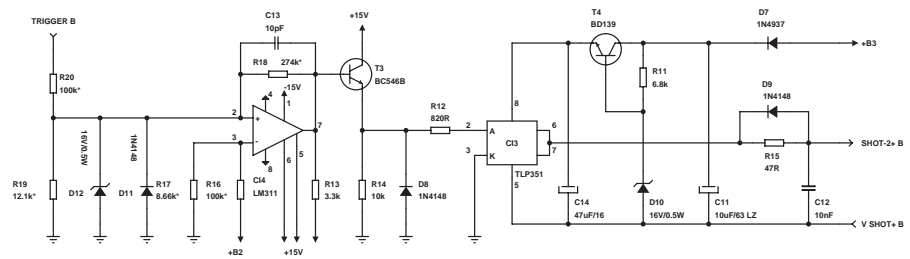
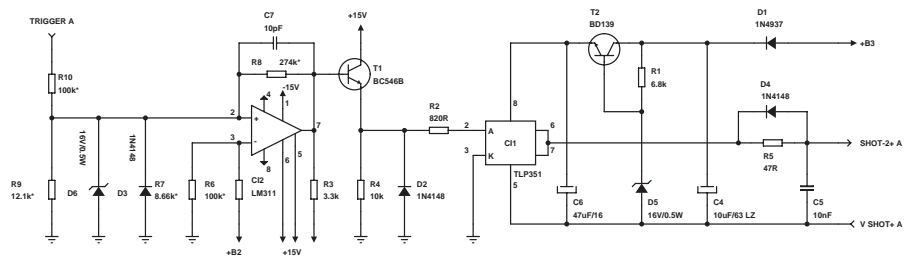

NOTA:
 -Resistores 5% 1/2W, quando não especificado
 -Capacitores 5%, quando não especificado
 -Sujeito a alterações sem aviso prévio



Desenhado por: **Alan**
 Revisão 1 por: **Adriano**
 Data: **25/09/2006**

Visto: _____
 Revisão 2 por: _____
 Data: _____

Visto: _____
 Seção: **SHOT**
 Equipamento: **PP-6002**

Versão: **01**
 Página: **1/1**

Observações: _____
 Recebido por: _____
 Setor: _____
 Visto: _____

